

I80 Series

Operator's Manual



PRINTEK MOBILE™

I80

**8-Inch Portable
Receipt Printer**

FCC Part 15 Class B

This device complies with Part 15 of the FCC Rules. Operation is subject to the following two conditions: (1) this device may not cause harmful interference, and (2) this device must accept any interference received, including interference that may cause undesired operation.

This equipment has been tested and found to comply with the limits for a Class B digital device, pursuant to Part 15 of the FCC rules. These limits are designed to provide reasonable protection against harmful interference in a residential installation. This equipment generates, uses, and can radiate radio frequency energy and, if not installed and used in accordance with the instructions, may cause harmful interference to radio communications. However, there is no guarantee that interference will not occur in a particular installation. If this equipment does cause harmful interference to radio or television reception, which can be determined by turning the equipment off and on, the user is encouraged to try to correct the interference by one or more of the following measures:

- Reorient or relocate the receiving antenna.
- Increase the separation between the equipment and the receiver.
- Connect the equipment into an outlet on a circuit different from that to which the receiver is connected.
- Consult the dealer or an experienced radio/TV technician for help.

This equipment complies with Canadian and FCC radiation exposure limits set forth for an uncontrolled environment. This transmitter must not be co-located or operating in conjunction with any other antenna or transmitter.

Part 15.21 Caution: Changes or modifications not expressly approved by Printek could void the user's authority to operate the equipment.

DASCOM	DECLARATION OF CONFORMITY	
Statement of compliance:		
The following products have been tested and comply with FCC Part 15, Subpart B and ANSI C63.4-2014 standard limits.		
Printek Branded Mobile Thermal Printers:		
Series/Model: Vehicle Pro series, VP420	Tested by: AGC Attestation of Global Compliance	Report number: AGC05548190101FE01, AGC05548190102FE01
Interceptor series, I820 Interceptor series, I80 FieldPro series, FPS30, FPS30L FieldPro FPS30sL Payload	EST Technology Co., Ltd EST Technology Co., Ltd EMTEK Co., Ltd AGC Attestation of Global Compliance	ESTE-R1709080, ESTE-R1709081 ESTE-F2109037 ES180516013E, ES180516014E AFCC05548180801FE01, AGC05548180802FE01
FieldPro FPS41 MLP Series, MLP35	WH Technology Corp. EST Technology Co., Ltd	CF17110506 ESTE-F1907016
Printek Branded Dot Matrix printers:		
FormsPro 5100 Series Printer PrintMaster 700 Series Printer	Underwriters Laboratory WH Technology Corporation	4788630615.1 CF16100107

These devices comply with Part 15 of the FCC rules. Operation is subject to the following two conditions: (1) These devices may not cause harmful interference, and (2) these devices must accept any interference received, including interference that may cause undesired operation.

Importer:
Dascom Americas
34 Lakeview Court
Verona, VA, 24482 U.S.A.
PH: 540-256-1570
<https://dascomamericas.com>

For Printek branded product information:
<https://www.printek.com>

Dascom President:
Signature: _____

Date: April 7, 2021



This device fulfills the European standards requirements by complying with the Directive relating to electromagnetic compatibility and relating to low-voltage electrical equipment. Furthermore, it fulfills the requirements for RoHS and R&TTE if applicable.

Conformity with the above-mentioned Directives is indicated by the CE symbol attached to the device.

Note: Conformity may be affected by:

- using interface cables not complying with the specifications
- non-observance of important instructions in the operator's manual
- installing components not approved for this device by the manufacturer
- unauthorized manipulation



Dieses Gerät erfüllt die Anforderungen der Europäischen Normen durch Einhaltung der Richtlinien bezüglich der Elektromagnetischen Verträglichkeit sowie bezüglich Elektrischer Betriebsmittel mit Niederspannung. Des Weiteren werden die Anforderungen bezüglich RoHS und falls anwendbar R&TTE erfüllt.

Die Konformität zu den oben angeführten Richtlinien ist durch das am Gerät angebrachte CE-Zeichen gekennzeichnet.

Hinweis: Die Konformität kann beeinflusst werden durch:

- Benutzung von nicht spezifizierten Schnittstellen
- Nichtbeachtung wichtiger Hinweise der Bedienungsanleitung
- Ersetzen von Bauteilen, die nicht vom Hersteller für dieses Gerät freigegeben wurden
- Eingriffe durch Unbefugte



This device complies with the requirements of the United Kingdom (UK) legislation of Electrical Safety Regulations, Electromagnetic Compatibility Regulations, if applicable the Radio Regulations and the Restriction of the Hazardous Substances in Electrical and Electronic Equipment Regulations.



 (Waste electrical products should not be disposed of with household waste. Please recycle where facilities exist. Check with your Local Authority or local store for recycling advice.)

TABLE OF CONTENTS

TABLE OF CONTENTS.....	III
Introduction.....	1
Printer Features.....	2
Quick Start Instructions.....	3
A. Paper Load (Media 8.5”).....	3
D. Power On.....	4
E. Control Panel	4
F. Performing a Printer Self-Test	4
G. Restore the Printer Firmware	5
Configuration.....	5
A. Connectivity Parameters.....	6
B. Image Parameters	11
C. Device Config	12
D. Fonts	13
E. Image Config.....	14
F. Graphics	17
G. Update Printer Firmware, Upload Files to Printer Memory	18
H. Reset Printer Configuration to Factory Defaults (Safe Mode)	19
Printing Modes	19
A. ASCII Based Print Jobs	19
B. Graphic Based Print Jobs	19
Integrating the Printer into your Business Applications Step by Step – Creating a Link from Host to Printer	20
A. Windows Desktop Computers.....	20
Print Drivers.....	20
I. USB	20
II. Bluetooth – General	24
III. Bluetooth – Windows 7 and above.....	25

II. Install Win 10 Ethernet Driver.....	Error! Bookmark not defined.
IV. Wi-Fi.....	27
B. Windows Tablets and Smartphones	Error! Bookmark not defined.
C. Android Tablets & Smart phones.....	27
I. Bluetooth	27
II. Wi- Fi	27
D. Apple™ Tablets & Smartphones	28
III. Bluetooth	28
IV. Wi-Fi.....	28
Media	28
A. Standard Media.....	28
B. Black Mark Media Position.....	28
Maintenance and Troubleshooting.....	29
A. Cleaning	29
C. Troubleshooting	29
I. General Error Conditions.....	29
II. Fault Description and Resolution	30
D. Obtaining Service	30
APPENDIX	31
A. Appendix A – I80 Printer Specifications.....	31
Glossary of Terms	32
Index	33

Introduction

Thank you for purchasing the I80 Series mobile thermal printer also referred to in this manual as the “I80”. The I80 series prints on special thermal media supplied in roll form up to 8 inches wide. All models are equipped with a USB port which supports cabled communications. All models support an optional internal Bluetooth or Wi-Fi interface. Complete specifications may be found in [Appendix A – I80 Printer Specifications](#).

The remainder of this manual focuses on preparing the printer for initial use and performing tasks that will be encountered during daily use.

[Maintenance and Troubleshooting](#) describes how to maintain the printer for optimal performance and has information on how to diagnose any problems that may occur.

Printer Features

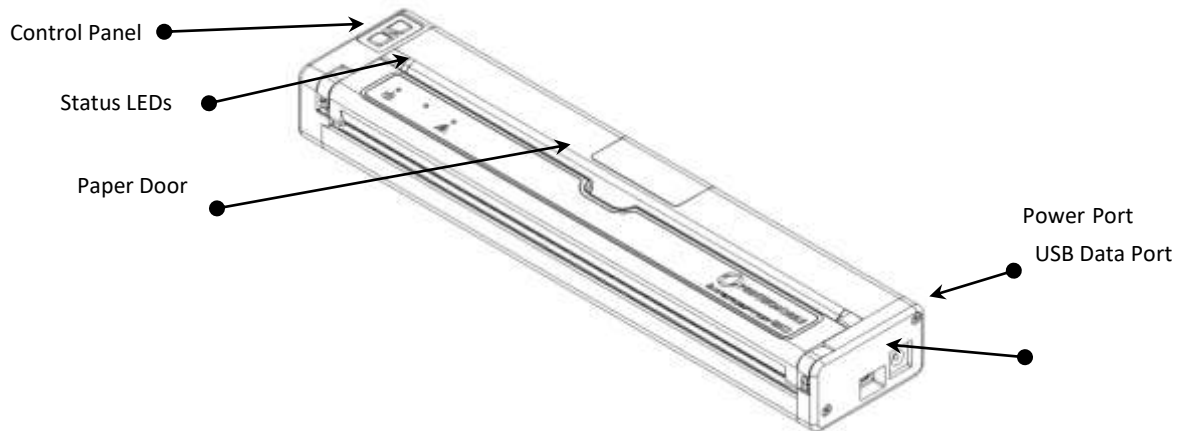

I80 features:

- Easy-to-read control face
- Printer can use single sheet paper, roll paper or black mark paper.
- Extensive fonts, character sets, bar codes and graphic capabilities.
- Printing speed up to 11 pages per minute.
- Printer configuration is quick and easy with a web-based interface.
- Compatible with Windows, Android and iOS.
- Emulations that allow the printer to be a drop-in replacement for nearly any mobile printer.

For detailed specifications reference [Appendix A – I80 Printer Specifications](#).

Quick Start Instructions

A. Paper Load (Media 8.5’')

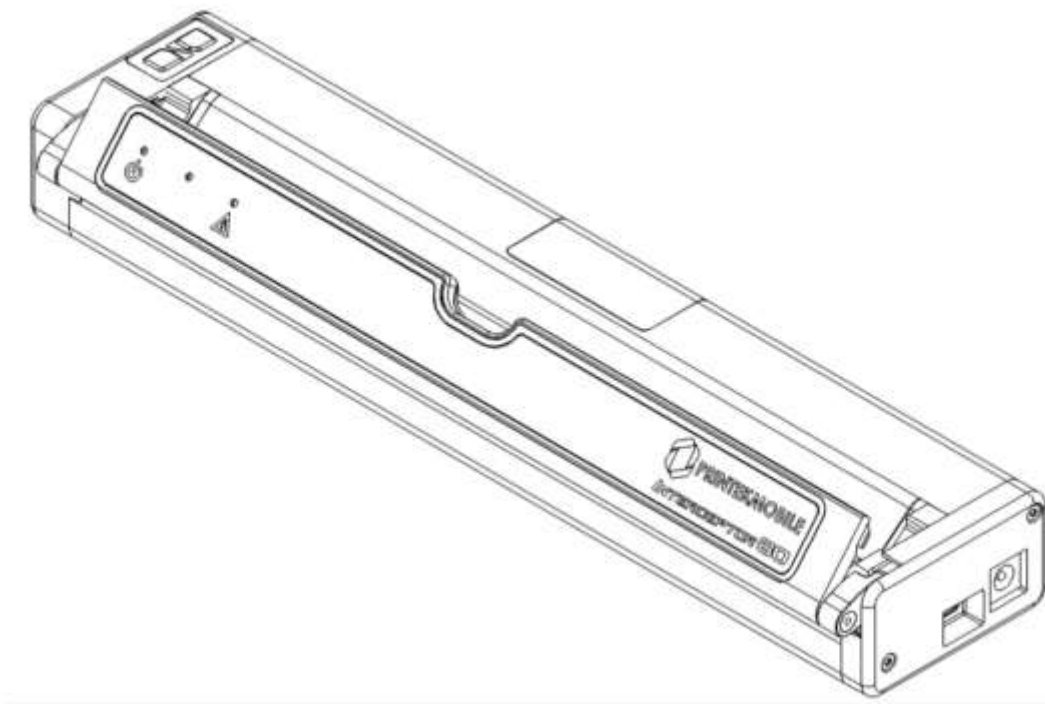

Roll Paper –

- Open the paper door by inserting your finger into the cutout in the paper door and gently pulling the door toward the front of the printer.
- Insert the leading edge of the paper roll into the printer with the coated side down.
- Close the paper door and push the paper feed button to ensure the paper is under the roller and able to advance.

Black Mark Paper –

- Open the paper door by inserting your finger into the cutout in the paper door and gently pulling the door toward the front of the printer.
- Insert the leading edge of the paper roll into the printer with the black mark facing up.
- Close the paper door and push the paper feed button to ensure the paper is under the roller and able to advance. If the printer is properly configured for Black Mark paper the paper should advance until the black mark is detected by the printer.



Single Sheet Paper -



- Insert a single sheet of paper with the coated side down into the top of the printer.
- The printer will grab the single sheet and place it into the printer ready to print.
- If the printer has received a print job, the printer will begin to print as soon as the paper is detected.

B. Power On

Depress the Power button on the control panel. The green LED and the red LED will both be lit while the printer is going through its startup sequence (about 20 seconds). The red LED will go off, leaving the green LED on to indicate the printer is ready to print.

C. Control Panel

Control Panel		
 Power Button	Power Up Power Down Toggle IP over USB on/off	Press & Release Press & Hold Press twice
 Paper Feed Button	Advance paper Print Setup Report	Press once Press twice

Power & Status (Green/Red) 	(Yellow) 	Alert (Red) 	Indication
On	Off	On	Booting up
On	Off	Off	Ready
On	Off	Flashing	Paper Error / Lid Open / Paper End
Flashing	Off	Off	Job is arriving
Flashing	Off	Off	Job is printing
Flashing	Off	Flashing	IP over USB active
Flashing	Flashing	Flashing	Restart the printer manually
Off	Off	Flashing	Restore the printer firmware
Off	Off	On	Print head too hot

D. Performing a Printer Self-Test



Before you connect the printer to the computer, make sure that the printer is in proper working order. You can do this by printing a configuration status page.

1. Make sure the media is properly loaded, the top cover of the printer is closed and the printer is powered on. Then, press the Feed button twice continuously.
2. The printer will print out a parameter setting page.

E. Restore the Printer Firmware

1. When the Power & Status LED is off, and Alert LED flashing, you need to restore the printer firmware. Turn on the printer and wait for around 30 seconds, the printer enters into configuration mode, and you could download the firmware via web.
2. If any problem occurs during firmware upgrade, and the printer fails to work, you could restore the printer firmware as such:
 - ① Use the AC adapter
 - ② Turn on the printer by holding both the feed button and power button for five seconds.
 - ③ With Power LED and Alert LED flashing, the printer enters into Configuration mode after 30 seconds.
 - ④ You can upgrade the firmware via the web.

Configuration

Configuration of the I80 printer is done through a built-in web page. This allows you to configure the printer from any device that has a browser and is compatible with your I80 communication capabilities.

1. Turn the printer ON.
2. Connect a USB cable between the printer and a PC.
3. To access the I80 web page, push the Power button twice rapidly. This will put the printer into Configuration mode.
4. When the printer is in Configuration mode the POWER and FAULT LEDs will flash together.
 - a. Open browser on your PC and type **169.254.200.1** into the address bar of the browser and hit Enter - A login box should appear:

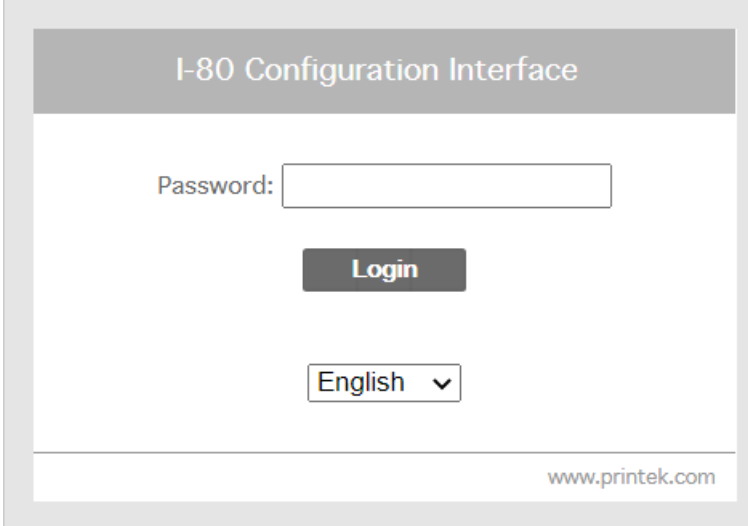

The screenshot shows a web browser window displaying the 'I-80 Configuration Interface'. At the top, there is a grey header with the text 'I-80 Configuration Interface'. Below the header, the word 'Password:' is followed by a text input field. Underneath the input field is a dark grey button with the text 'Login' in white. Below the 'Login' button is a dropdown menu currently showing 'English' with a downward-pointing arrow. At the bottom right of the page, the URL 'www.printek.com' is visible.

- b. Type "0000" and hit Enter- you should now be at the home page for I80 Configuration.

5. The main configuration screen of the I80:

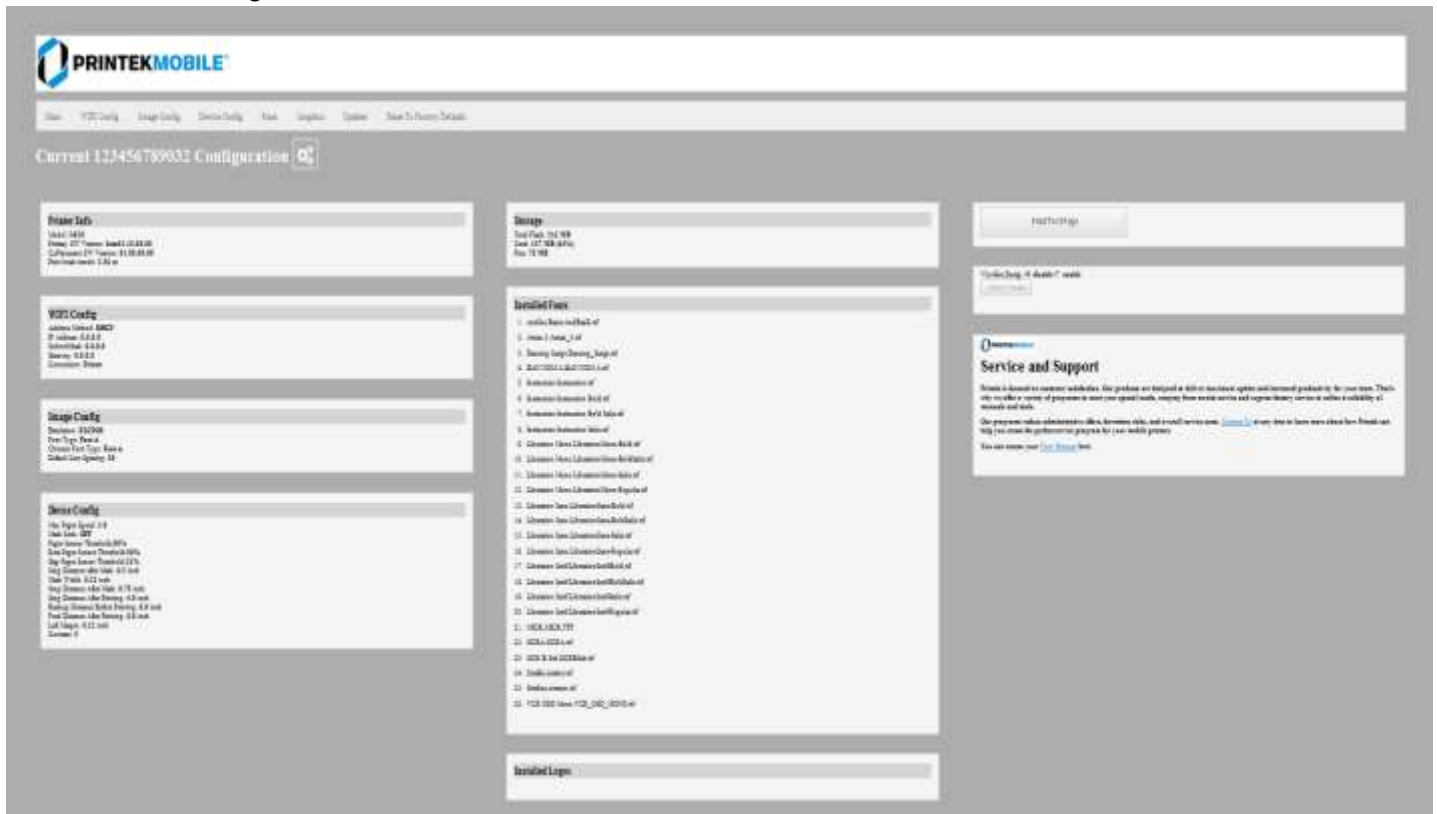

This is an overview of the printer configuration.

To return the printer to normal operating mode, double-click the Power button. The POWER LED will be returned to a solid light.

At the top of the Main Page are selections to access the sub-menus.

A. Connectivity Parameters

This page allows you to set up the connection to your printer. Depending on the optional interface installed, you will see either Bluetooth Config or WI-FI Config. In the detailed descriptions, an asterisk (*) indicates the factory default value.

Bluetooth Config:

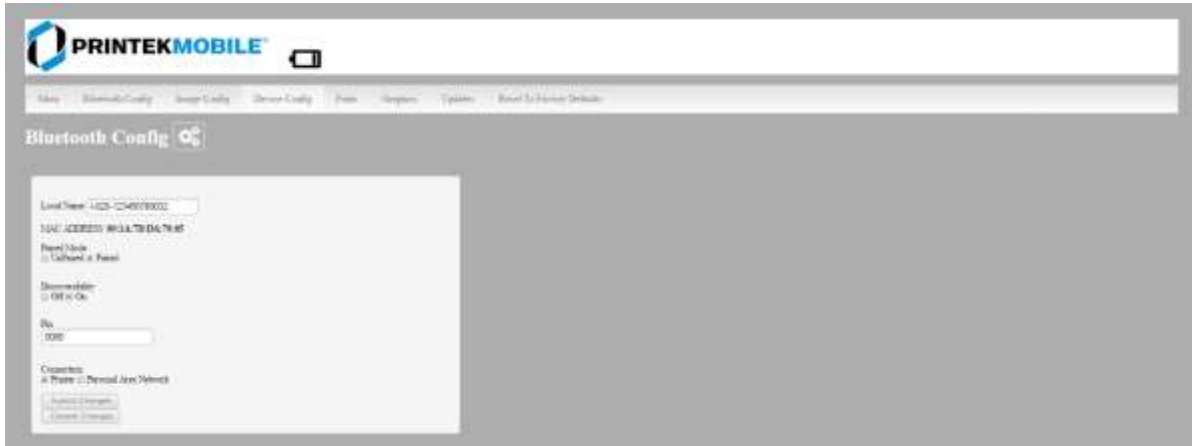

Paired Mode:

Possible values: UnPaired, Paired*

This feature allows Bluetooth pairing to occur between the printer and the connecting device whenever Pairing is required by either device. Pairing requires that the PIN on the printer and the connecting device exactly match each other.

Discoverability:

Possible Values: Off, On*

This feature is used to set whether the printer may be discovered by other Bluetooth devices. It should only be set to "Off" after the printer has been discovered and paired with a host computer.

PIN:

Possible Values: 0000*, Up to 16 Numeric Characters.

Note that this feature is only available if Pairing Mode is set to "Paired". The PIN value must exactly match the PIN value set in the Bluetooth manager on the host computer.

Connection:

Possible Values: Printer*, Personal Area Network

This feature selects the role of the printer's interface in the Bluetooth network.

In Printer mode, the printer behaves as a regular Bluetooth device.

In Personal Area Network mode, the printer behaves similar to a Wi-Fi access point.

The Power LED will flash off every two seconds while in this mode.

After pairing with the printer, the host Bluetooth icon will appear different, indicating that an access point is present.



Some hosts require an extra connect step after pairing. After connecting, the printer will issue an IP address to the host and the host can communicate to the printer as if it were a Wi-Fi printer. The printer's address to the host is always **169.254.200.1**

In the host device's browser (if equipped) this address may be entered in the address bar to access the printer web page.

Personal Area Network mode can also be activated outside of the printer web page.

To enter Personal Area Network mode, press and hold the Power and Paper Feed buttons until the Power and Alert LEDs light. Release both buttons, and the printer will restart in Personal Area Network mode. To exit Personal Area Network mode, press and hold the Power and Paper Feed buttons until the Power and Alert LEDs light. Release both buttons, and the printer will restart in normal Bluetooth mode.

WI-FI Config:



Wireless Configuration

This will display the current Wi-Fi configuration:

IP Address – user defined. If Static Address Method is selected, type in the address the printer will use on the network.

SubNetMask – user defined. If Static Address Method is selected, type in the subnet mark of the network.

GateWay – user defined. If Static Address Method is selected, type in the gateway address of the network.

WiFi Port – default value = 8023

Address Method – user selectable

Static – printer will always connect to the network using the IP address defined.

DHCP – printer will acquire an IP address from your network DHCP server.

Access Point – printer will acquire an IP address from your WiFi access point.

Personal Area Network –The printer will broadcast itself as a network connection. The Power LED will flash off every two seconds while in this mode. The SSID will be the serial number of the printer.

When connecting to the printer, the passphrase is the printer's serial number.

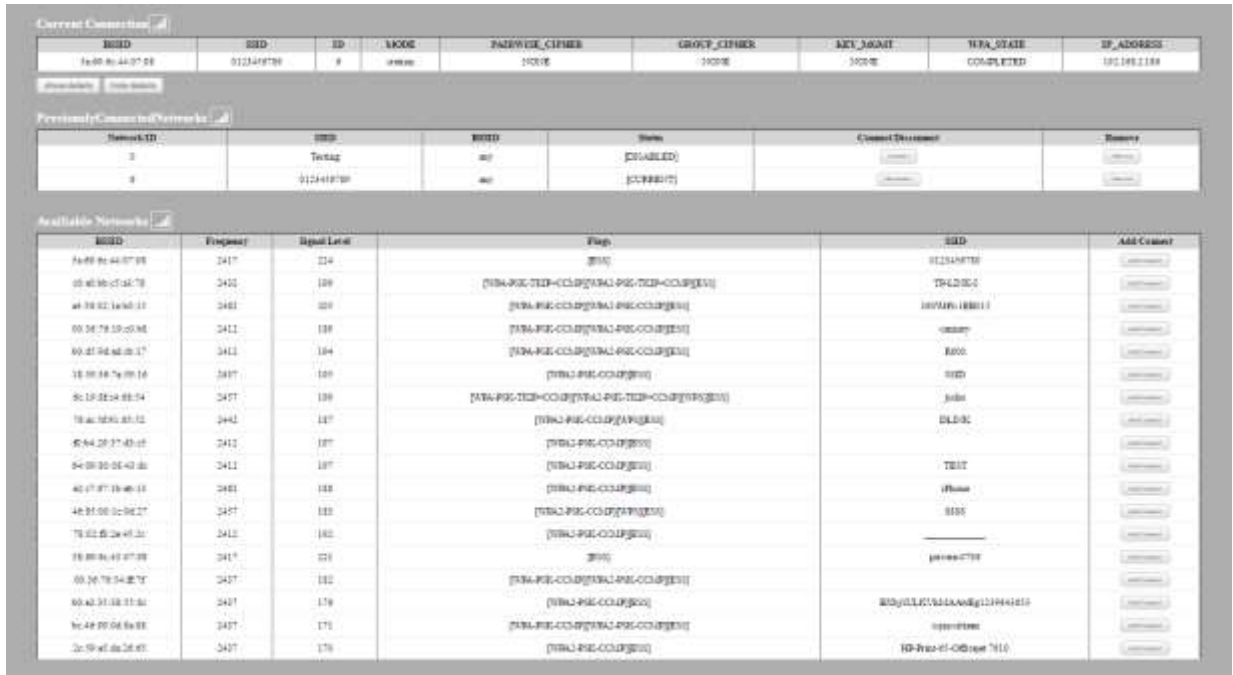

Available Networks – access points detected by the printer will be displayed. Select Add/Connect to use one of these access points.

Previously Connected Networks – access points detected by the printer or added through Add/Edit Network will be displayed. Select Connect to use one of these access points or Remove to delete it from printer.

Currently Configured Networks – access points added through Add/Edit. They may not have been connected yet. Select Remove to delete access point from printer.

Add/Edit Network

Enter the SSID of a network connection. If authentication is used select the authentication type. Click Next. The following form will change depending on the authentication type:

B. Image Parameters

This page allows you to make selections about the image to be printed.



The screenshot displays the 'Image Config' page of the PRINTEKMOBILE interface. The page has a navigation bar with links for Menu, WiFi Config, Image Config, Device Config, Fonts, Graphics, Updates, and Reset To Factory Defaults. The 'Image Config' section is active and shows a table of settings:

Encoding	GB18030 @ UNICODE @ UTF-8
Current Emulation	ESCPOS
Font Type	Font A Font A: 12*24 Font B: 9*17
Letter Spacing	Art Style
Digit Spacing	Normal
Change Font Type	Font A Font A: 24*24 Font B: 32*32
Character Type	CP864
Default Line Spacing	30 Unit: point

At the bottom of the form, there are two buttons: 'Submit Changes' and 'Discard Changes'.

Current Emulation:

ESCPOS is the default emulation in I80

Possible Values: PRINTEK, ZPL, CPCL, ESCPOS*, AUTOIMAGE, PDF, POSTSCRIPT, IMAGE

The I80 printer is capable of using several different emulation modes. This feature sets the family of printer commands that may be used by a host application program to control the various capabilities of the printer. The printer will only respond to commands valid for the currently selected emulation. For more information, please refer to the *Integrator's Guide*.

Besides the popular printer languages to choose from, the following selections allow the I80 to print many other file formats directly, without the need for a driver.

AUTOIMAGE – selected when mixed PDF and POSTSCRIPT images are sent to the printer. The printer will determine which type of file has been sent. This can increase printer response time.

PDF – When in this mode the printer will directly print Portable Document Files (PDF).

POSTSCRIPT – When in this mode the printer will directly print Postscript formatted files (.ps). You can also use a generic Postscript driver to print when in this mode.

IMAGE – selected if just image files are being sent to the printer. When in this mode the printer will directly print the following file types: .png, .jpg, .bmp, .pbm, .svg, .tif

Default Font:

The I80 has the ability to use True Type Fonts. All True Type Fonts loaded into printer memory are listed here. When using emulations that do not specify the font for each line of text, select the font you would like to use as the default font. All print jobs will use the default font unless a command is sent to the printer to use another font.

Chars Per Inch and Default Text Line Spacing:

This determines how large the characters are and how many characters will print in a one inch space. The higher the number, the greater the number of lines per vertical inch of print.

C. Device Config

This page allows you to set certain hardware parameters on the printer.

Unit	Unit
Max Paper Speed	76.2 mm/sec
Mark Seek	Roll Paper
Paper Sensor Threshold	80 %
Backup Distance Before Printing	0.0 inches
Feed Distance After Printing	0.0 inches
Left Margin	0 inches
Contrast	10
Power Sleep	On

Paper Sensitivity

Threshold paper settings

Locked

Default paper type

Units

Select between inches or millimeters. If you change units, do so before entering other settings.

Max Paper Speed

Possible values: 25.4 to 76.2 mm, Default = 76.2

When using labels or heavy paper stock, you may need to decrease the paper speed to prevent paper jams.

Mark Seeking

Possible values: roll paper, black mark paper, and cut sheet paper.

Set the value when using regular or label media with black alignment marks.

Note: Before adjusting black mark thresholds, set mark width to match the width of the black mark.

Paper Sensor Threshold

When using paper with a black on the front adjust this setting to ensure the paper stops at the black mark.

1. Set paper sensor threshold: white paper has relatively smaller sensor brightness while black paper has relatively bigger sensor brightness. When sensor brightness is bigger than paper sensor threshold, printer could detect black mark. Otherwise, printer could not detect black mark. In the latter case, users have to lower paper sensor threshold. For example, when printer stops in the middle of white paper, users could increase the paper sensor threshold. The recommended value is between 75% ~ 95%.
2. Close lid and press paper feed. The paper should stop with the bottom of the form at the tear bar.

Backup Distance Before Printing

Used with Mark Seek. User defined. This is the distance the printer will pull in the paper before starting to print.

Feed Distance After Printing

Used with Mark Seek. User defined.

Mark Seek Distance

Used with Mark Seek. User defined. This is the distance the printer will advance paper to seek the mark before displaying a Paper Out condition.

Stop Distance After Mark

Use with Mark Seeking. User defined. This is the distance the printer will advance the paper after the mark is detected.

Mark Width

Use with Mark Seeking. User defined.

Left Margin

Setting this value will tell the printer how far from the left edge of the paper to start the print job.

Contrast

Possible values 0 – 10. Default value is 5

The lower the value the lighter the print. The higher the value the darker the print.

Paper Sensitivity

This is a locked value. These settings are supplied by the paper manufacturer. The default settings cover most grades of paper. If you are using non-standard paper consult the paper manufacturer for recommended settings.

Power sleep

Possible values: **Disabled, 10, 30, 60, 120, 180** minutes. Default value is **Disabled**.

This timer will turn the printer off if it has not been used for the time set. Disable this feature by setting the time at **Disable**.

D. Fonts

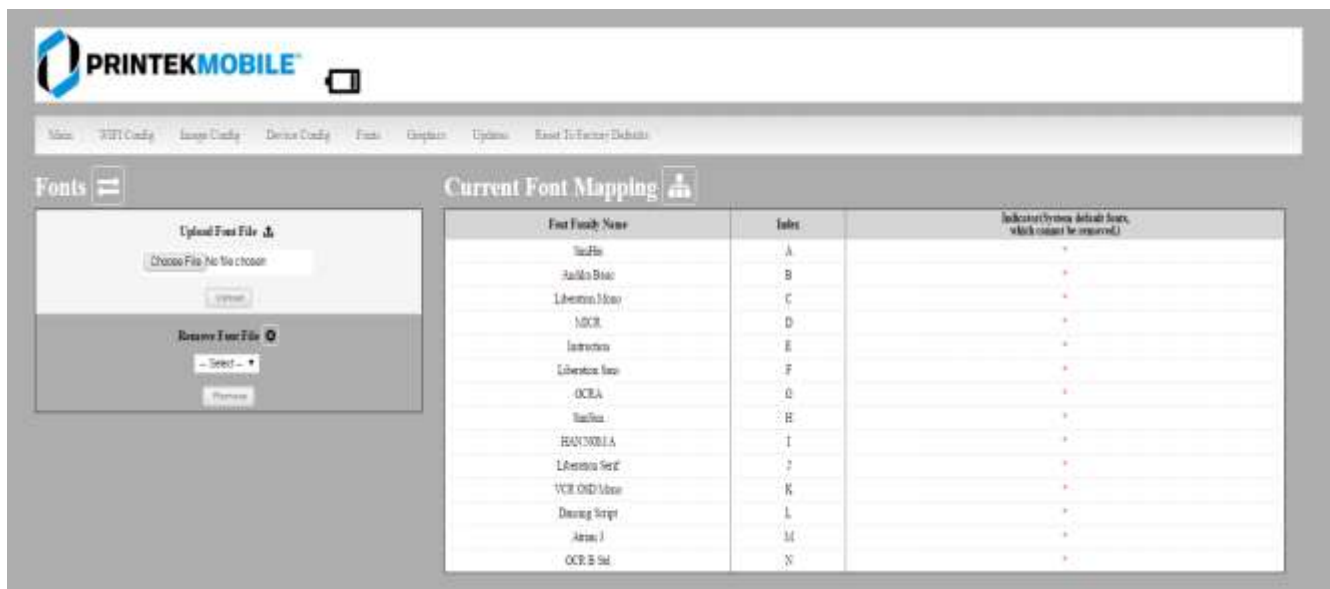

The screenshot shows the Printek Mobile web interface. At the top, there is a navigation menu with links: Home, WiFi Config, Image Config, Device Config, Fonts, Displays, Updates, and Reset To Factory Defaults. The main content area is titled 'Current Font Mapping' and features a table with the following columns: 'Font Family Name', 'Index', and 'Indicator (Shows default fonts, which cannot be removed)'. The table lists various font families and their corresponding indices, with a red asterisk in the indicator column for each row.

Font Family Name	Index	Indicator (Shows default fonts, which cannot be removed)
YujiHo	A	*
YujiHo Bld	B	*
Libertine Mono	C	*
MSDF	D	*
Instruction	E	*
Libertine Mono	F	*
OCEA	G	*
YujiHo	H	*
FRANSVILLE	I	*
Libertine Serif	J	*
VCR OSD Mono	K	*
Dancing Script	L	*
Arms J	M	*
OCR B Std	N	*

Upload Font File

TrueType Fonts (.ttf, .otf, .ttc and .bdf) can be uploaded here.

Languages like ZPL and CPCL can use the fonts by referring to them by their Font Family Name.

E. Image Config

User Define ESCPOS fonts

Enter Image Config – Current Emulation to set ESCPOS emulation fonts.

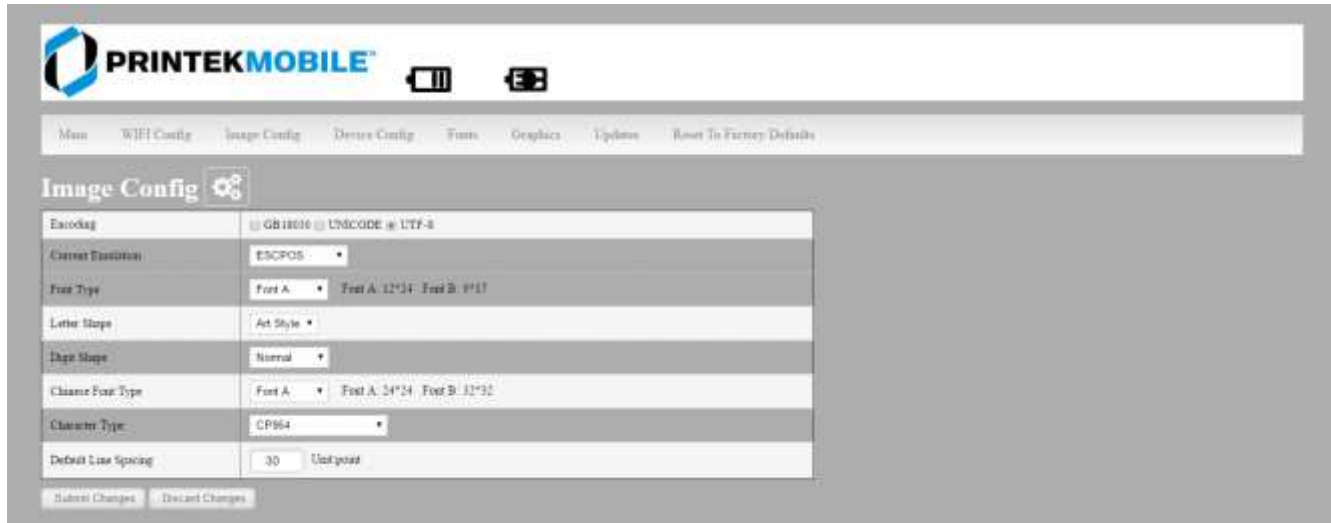

User Define Western Fonts

Font A:

Font A: Letters and numbers print in FontA by default. The parameter of FontA is 12 * 24. For letters you could choose among three types of typeface: art font, Song, equal-line face.

For numbers you could choose among three types of typeface: normal, bank, and OKI numbers. (If the command entails changing the font, the printer will use specific font.)

Letters

Art Font	ABCDEFghijk
Song	ABCDEFghijk
Equal-line face	ABCDEFghijk

Numbers

Normal	1234567890
Bank	1234567890
OKI number	1234567890

Font B: Letters and numbers print in FontB by default. The parameter of FontA is 9 * 17. Use system default font and cannot be changed.

Printout:

fontA: ABCDEFghijk

fontB: ABCDEFghijk 1234567890

User-defined: Users could change the size and font, using the system font and uploaded fonts. (If the command entails changing the font, the printer will use specific font.)

eg:

User-defined: 9 pounds. Western font file: STHUPO.TTF

ABCDEFghijk 1234567890

User Define Chinese Fonts

Font A: set in default. Parameters: 24 * 24. Use system default font and cannot be changed.

Printout:

中文字体 FontA

Font B: set in default. Parameters: 32 * 32. Use system default font and cannot be changed.

Printout:

中文字体 FontB

User-defined: Users could change the size and font, using the system font and uploaded fonts. (If the command entails changing the font, the printer will use specific font.)

eg:

User-defined size : 9 pounds Western Font File: STHUPO.TTF

自定义中文字体

User Define PRINTEK Fonts

Enter Image Config – Current Emulation to set PRINTEK emulation fonts.

(1) Default font: Liberation Mono:LiberationMono-Regular.ttf.

Liberation Mono:LiberationMono-Regular.ttf:

1B 40 2F 2A 2D 30 31 32

Printout :

33 34 35 36 37 38 39 3B

3A 3C 3D 3E 3F 40 41 42

43 44 45 46 47 48 49 4A 4B

4C 4D 4E 4F 50 51 52 53 54

55 56 57 58 59 5A 0D 0A

@/* -0123456789; :<=>?@ABCDEFGHIJKLMN OPQRSTUVWXYZ

OCRA:OCRA.ttf:

1B 40 2F 2A 2D 30 31 32
33 34 35 36 37 38 39 3B
3A 3C 3D 3E 3F 40 41 42
43 44 45 46 47 48 49 4A 4B
4C 4D 4E 4F 50 51 52 53 54
55 56 57 58 59 5A 0D 0A

Printout :

@/*-0123456789:;<=>?@ABCDEFGHIJKLMN0PQRSTUVWXYZ

User Define ZPL Fonts

- (1) Use CW command to define font.
- (2) CW command:
CW {font mark},R:{font file name} eg : CWL,R:simsun.ttf
- (3) CW command set font valid before printer restart.
- (4) User-defined font sample :

eg1:

^XA
^CWL,R:simsun.ttf
^FO10,10
^ALN,70,30
^FDABCD123^FS
^XZ

Printout :

ABCD123

eg2:

^XA
^CWL,R:simhei.ttf
^FO10,10
^ALN,70,30
^FDABCD123^FS
^XZ

Printout :

ABCD123

User Define CPCLFonts

- (1) Use TEXT command to define font.
- (2) TEXT command:
{command} {font} {size} {x} {y} {data}, {font}:font name/number; {size}:font size;
{x} : horizontal position; {y} : vertical position; {data}:printing data;
eg : TEXT 1 1 20 5 0123456789ABCDEFG

Sample :

eg1:

! 0 200 200 300 1

TEXT 1 1 20 5 0123456789ABCDEFG

CENTER

PRINT

Printout :

0123456789ABCD

eg2:

:

! 0 200 200 300 1

TEXT 5 1 20 5 0123456789 ABCDEFG

CENTER

PRINT

Printout

0123456789ABCD

F. Graphics

This menu will allow you to load a graphics file into printer memory for use in creating your output. For instance, logos can be stored for recall and use by your host program (see *Integrator's Guide* for more details).

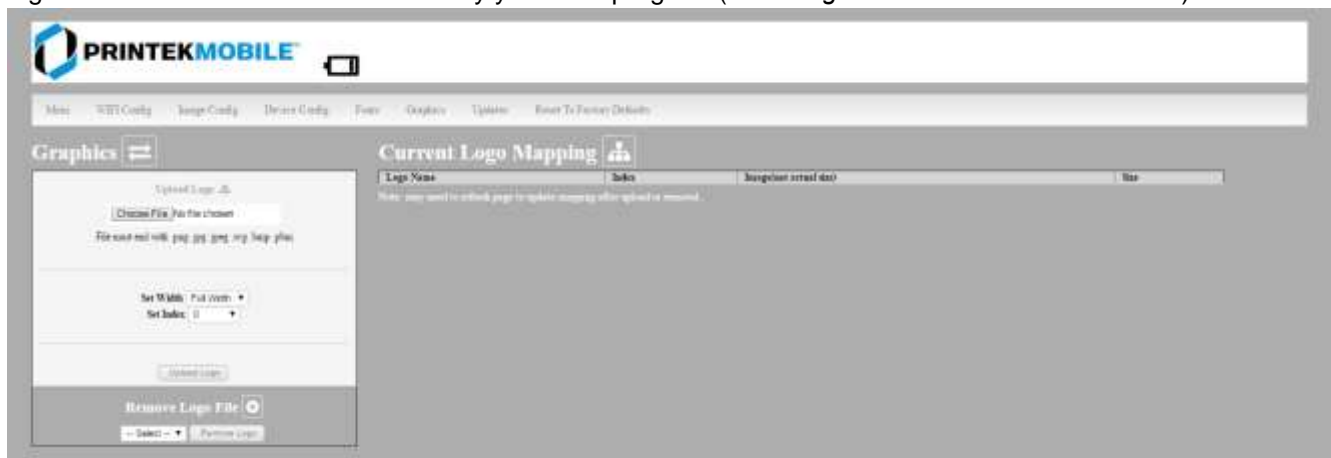

Upload File

Select the graphics file to load into printer memory. Acceptable graphics formats are .jpeg, .pbm, .pcx, .bmp, .png and .svg.

Set Width

Select the width you want to use to display your logo: full width, half width, or quarter width.

Set index

Depending on the Index value used, you can automatically print the graphics file as a header (prints at the beginning of the print job), footer (prints at the end of a print job) or use the graphics print command to print anywhere on your receipt or label. See *Integrator's Guide* for more information on graphics commands.

When selecting header, the graphics file will automatically print the logo at the beginning of each print job. When selecting footer, the graphics file will automatically print the logo at the end of each print job.

You must set each of these values before selecting Upload Logo or the default values will be associated with your image.

Current Logo Mapping

Once uploaded into the printer memory, your image and settings will be displayed here.

Logo upload procedure: 1. Choose logo file, 2. Set the width, 3. choose the index. 4. Upload it

Delete logo procedure: 1. Choose logo 2. Delete it.

G. Update Printer Firmware, Upload Files to Printer Memory



Procedure:

1. Enter the config page
2. Click Updates.
3. Choose Upload Firmware, choose file and click Upload.
4. After uploading .tgz or .sw file, printer will restart itself. After uploading .fw file, the three LEDs will flash. Users should restart the printer.

Notice: If fail to upload firmware, which shows as alarm LED flash, power and charge LED off after printer on, users could upload the firmware again because the printer enters into configuration mode after charging for 30 seconds.

Printer Application Updates, OEM information and Manuals and more can be uploaded here. Contact Printek retailer for more information.

H. Reset Printer Configuration to Factory Defaults (Safe Mode)

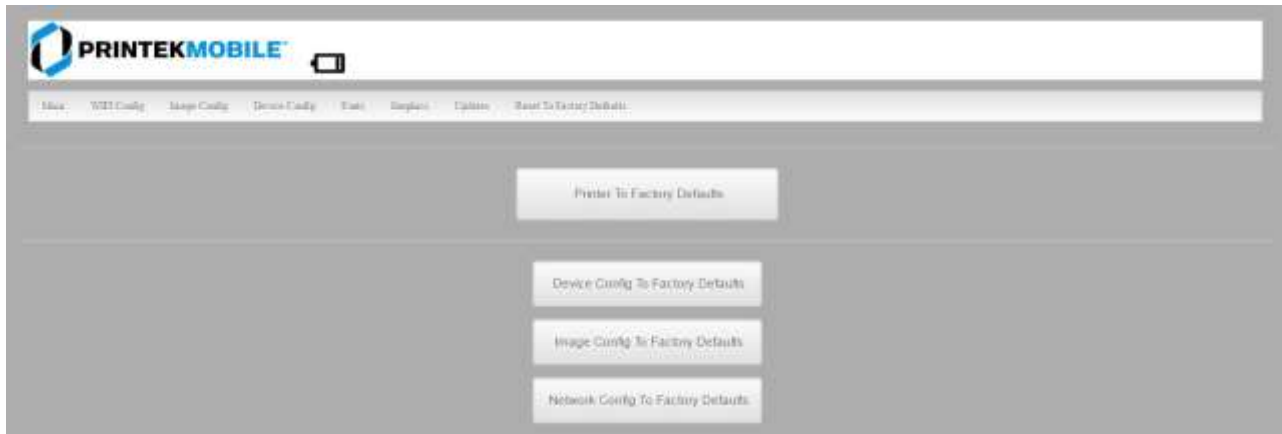

Printer to Factory Defaults: Printer settings can be restored to factory configurations.

Device Config to Factory Defaults: Printer settings can be restored to factory configurations.

Image Config to Factory Defaults: Printer emulation settings can be restored to factory configurations.

Network Config to Factory Defaults: WiFi and Bluetooth settings can be restored to factory configurations. Note that WIFI network configurations will be lost when Network Config to Factory Defaults is checked.

Printing Modes

There are two fundamental printing modes with mobile printers.

A. ASCII Based Print Jobs

The host sends the print job as a series of lines of characters, some of which represent the text to be printed, while other portions are command codes which tell the printer which font to use, where to locate the text, what barcodes to use, etc. These text-based files are encoded in a print language specific to the target printer.

The I80 understands ASCII based jobs in several different print languages. Refer to the [Appendix](#) or the *Integrator's Guide* for the list of print languages supported.

B. Graphic Based Print Jobs

The host assembles the printed image as a series of lines of dots and transmits this image as a sequence of data bytes that represent the dot patterns assembled. Often these jobs or files have some control characters on the front end and / or rear end of the dot pattern bytes to define their format, help control pagination, etc.

Windows drivers in particular encode the image as a graphic based print job before it is passed along to the printer.

In addition to accepting graphic jobs from its Windows driver, the I80 can accept and print directly many other graphic image file types. This opens up the option to print job images from a variety of devices for which drivers or print utilities don't exist, such as some tablets and smartphones.

Please see the *Integrator's Guide* or your system integrator for more details.

Integrating the Printer into your Business Applications Step by Step – Creating a Link from Host to Printer

A. Windows Desktop Computers

Print Drivers

You may download the appropriate Windows driver from our website. Install the printer driver by the standard method for your version of Windows.

I. USB

- a) Connect the printer to the PC using a USB-C cable before using the automatic install.
Open DriverSetup.exe.

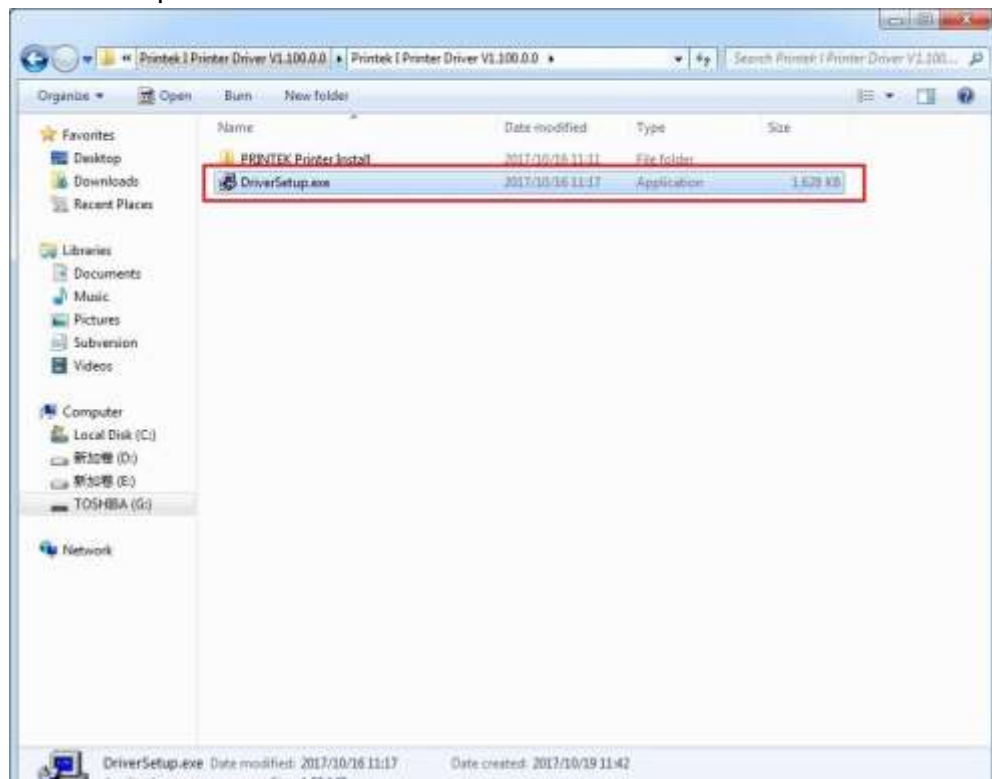

b) Select installing language.



c) In the popup window, select Next to proceed. It pops out the tab 'Please select installation method'. Click OK for automatic installation; click Cancel for manual installation.

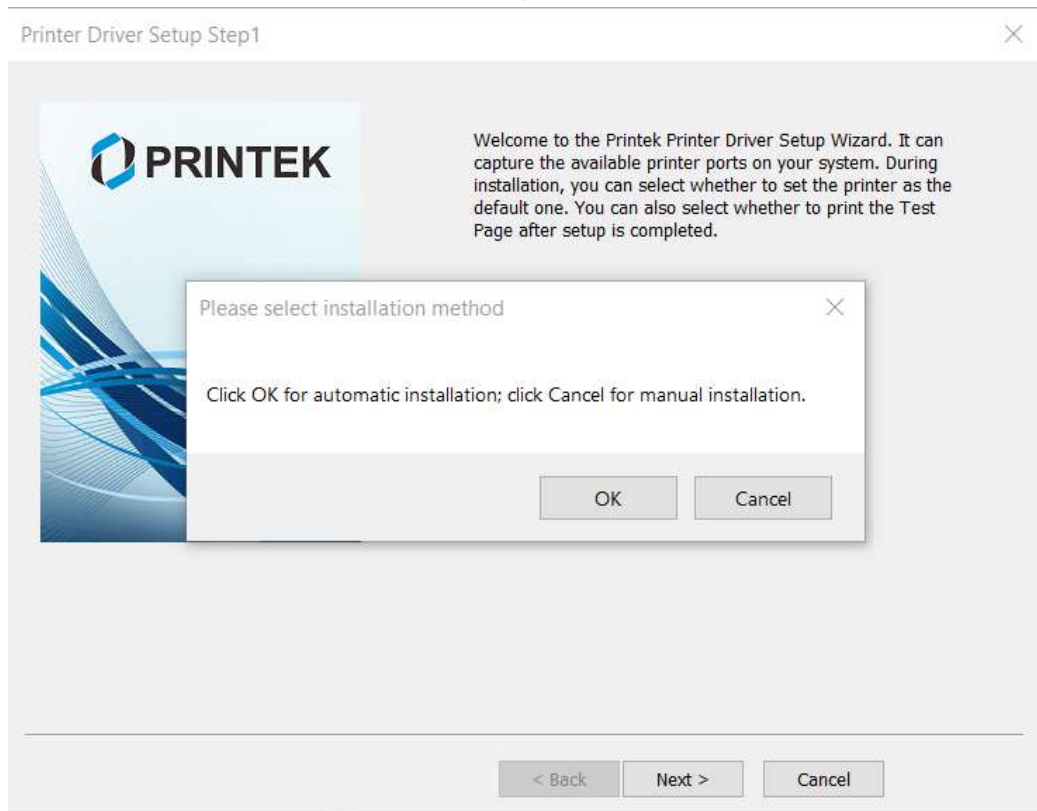

- d) For automatic installation, the system chooses PRINTEK I80; for manual installation please choose I80. Then click Next.

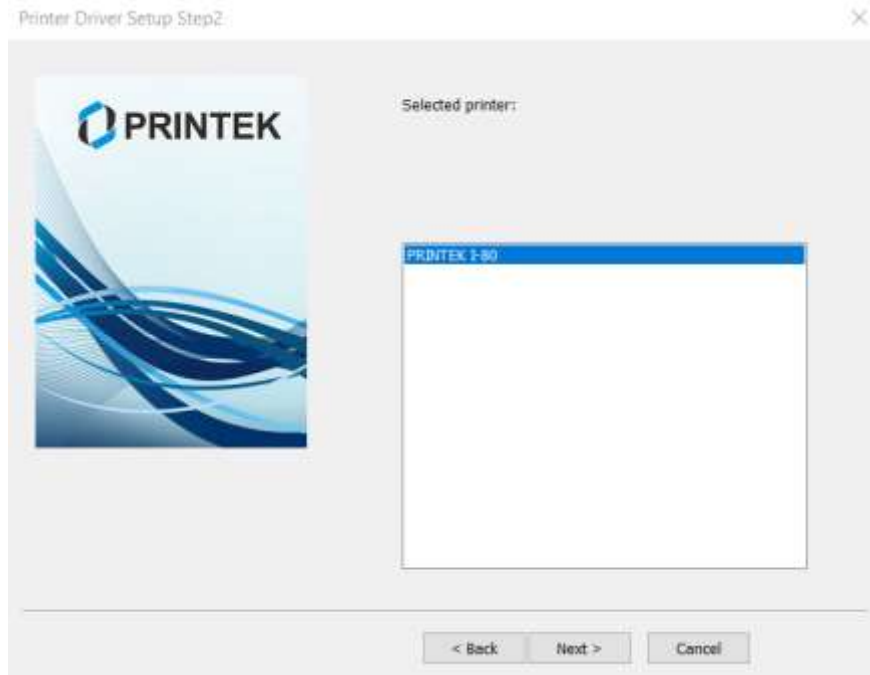

- e) For automatic installation, the system chooses USBxxx port that Windows assigned to the printer when it was connected through the USB connection. If you are not connected to a USB connection to your host system select the correct port. See below to determine the COM port Windows assigned to your connection if you are connected through a Bluetooth connection.

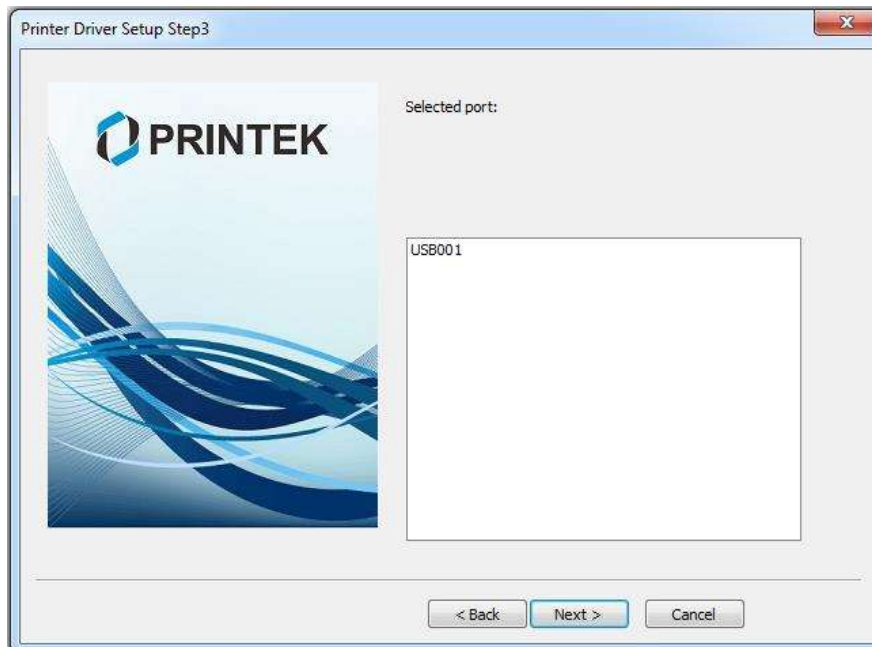

f) Click Next to proceed.



g) Click Finish to proceed.

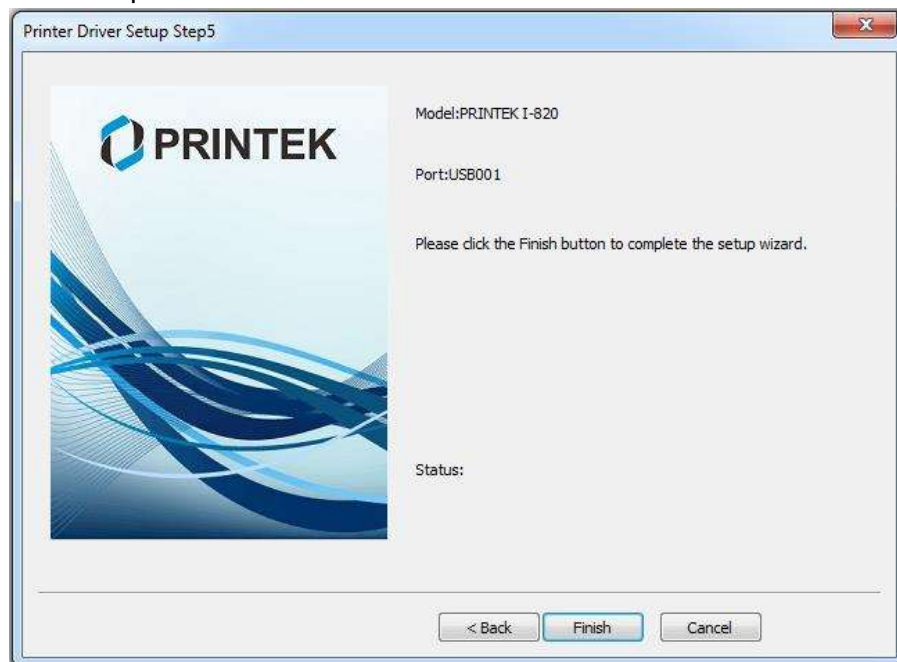

h) Click Install to proceed.



i) Installed successfully.

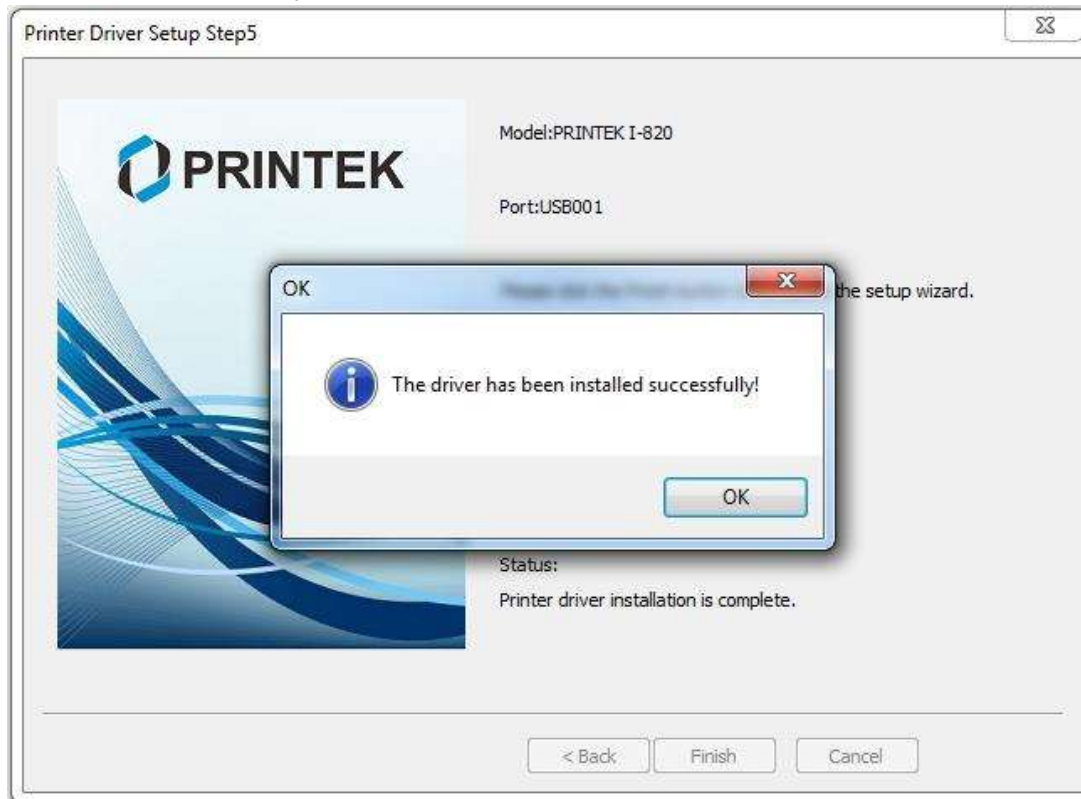

II. Bluetooth – General

- Turn on the printer. Make sure Bluetooth on your host device is turned ON.
- Your host Bluetooth manager may automatically scan for new devices, or you may need to tell it to scan. The discover name of the I80 printer will be "I80-xxxxxxxxxxx", where xxxxxxxxxxxx = the Printer Serial Number.
- For Pairing, the default passkey is "0000".

III. Bluetooth – Determining the Bluetooth COM port

Windows 10 –

- a) Open Windows Settings
- b) Select Devices
- c) In Bluetooth & other Devices select Related settings - More Bluetooth Options
- d) Select the COM ports tab.
 - a. The COM port that is assigned to the connection is the OUTGOING port. This is the port number to use when installing the driver.

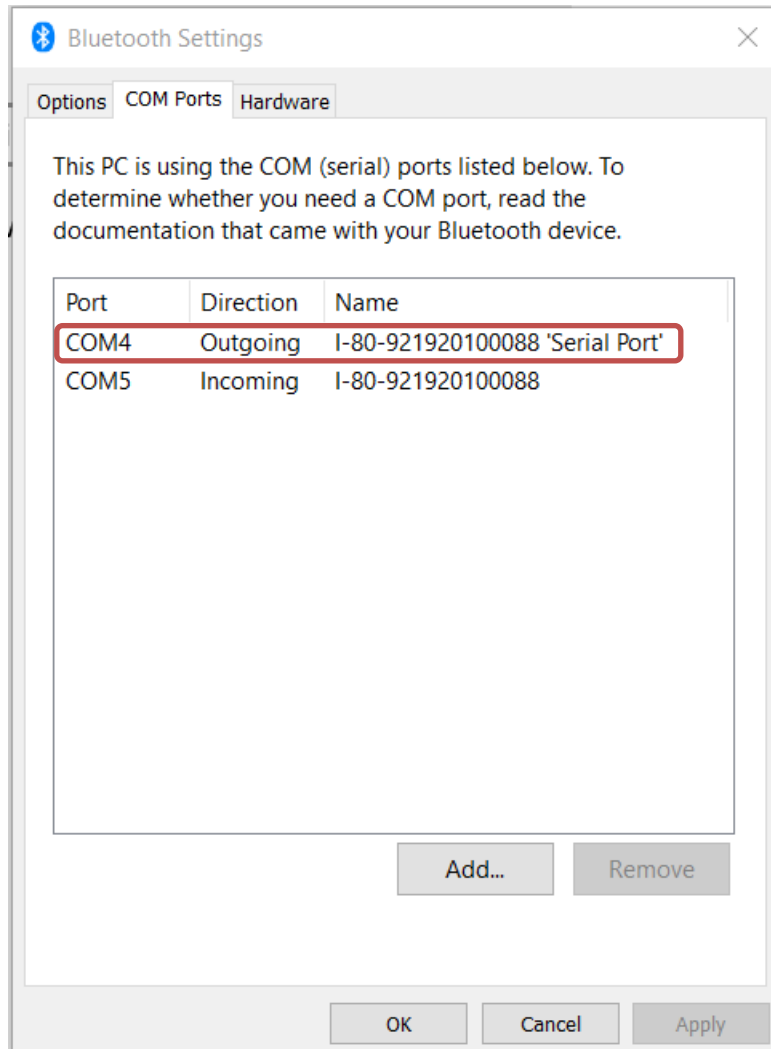

Windows 7 –

- a) Open Devices and Printers
- b) The printer should be displayed by the discover name.
- c) Right click on the printer icon.
- d) Select Properties.
- e) Select the Services tab.
 - a. Uncheck Generic Access Profile
 - b. Uncheck Generic Attribute Profile
 - c. The serial port assigned to the Bluetooth connection will be listed.

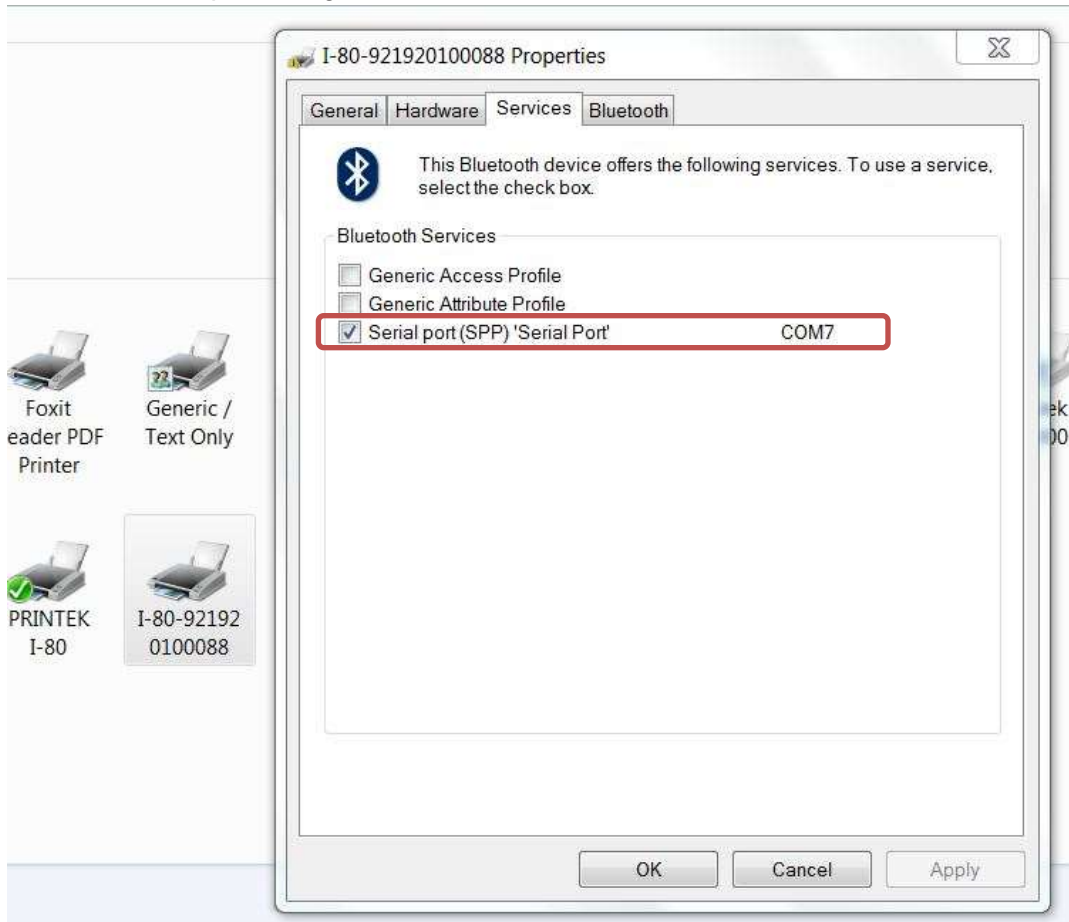

IV. Wi-Fi

Note: The following instructions are fundamentally the same for an Infrastructure or Wi-Fi Direct (peer to peer) setup. They also assume that you have already configured your Wi-Fi interface via the I80 printer web page (see the section on Configuration).

- a) Perform a configuration printout to verify the printer Wi-Fi setup and to record the IP address assigned and the Port number.
- b) Install the printer as a local printer using the USB instructions above.
- c) In the “Devices and Printers” screen, right click the printer icon representing your mobile printer.
- d) Under Printer Properties, select the Ports tab, then select “Add a Port”
- e) In the new dialog box which appears, select “Standard TCP/IP ports”; this will open the Standard TCP/IP Printer Port wizard.
- f) Follow the on-screen prompts in this wizard. You’ll use the IP address recorded above to set up the port. In the same screen you can also name the port something familiar and relevant, and this will appear as the name of the printer to the user.
- g) After the port is detected, it will be displayed as a “generic network card” – accept this by clicking Next / Finish.
- h) After you are finished adding the port, Windows will report it as a “Standard TCP/IP port”; click OK to accept this.
- i) Close the Printer Port window.
- j) Now in the Printer Properties dialog box your IP address (or the familiar name you assigned above) will appear in the list of ports available. Select it to configure the port.
- k) Windows defaults standard TCP/IP ports to port number 9100. The I80 Wi-Fi port number is internally set to 8023. Change the port number to 8023 in the Windows screen and click OK.
- l) Click “Apply” in the Printer Properties box.
- m) Your I80 printer driver should now be properly coupled to the Wi-Fi parameters you have chosen.

B. Android Tablets & Smart phones

I. Bluetooth

- a) Turn on printer. Make sure Bluetooth on your host device is turned ON.
- b) Your host Bluetooth manager may automatically scan for new devices, or you may need to tell it to scan. The discover name of the I80 printer will be “I80-XXXxxxxx”, where XXXxxxxx = the Printer Serial Number.
- c) For Pairing, the default passkey is “0000”.
- d) The printer should appear in your paired devices list.

Note: Android devices pair after discovery, but only **connect** to Bluetooth printers when the host application has asked it to print.

II. Wi- Fi

This feature and/or specific directions for use were not available as of this printing.

C. Apple™ Tablets & Smartphones

I. Bluetooth

This feature and/or specific directions for use were not available as of this printing.

II. Wi-Fi

This feature and/or specific directions for use were not available as of this printing.

Media

A. Standard Media

Printek offers a variety of media types. See [Appendix C](#) for detailed descriptions and ordering information. You may also visit our website or contact your PrintekMobile sales representative for a complete and up to date description of our consumables and accessory products.

B. Black Mark Media Position

For automatic ticket printing, the Black Mark should be positioned as shown in the figure below. When using Mark Sensing mode (see [Configuration](#), earlier in this document), FieldPro printers will automatically position the output for tear-off and printing following a Form Feed command or by pressing the Paper Feed button.

For non-automatic paper positioning, refer to the *Integrator's Guide* for sensing and positioning commands.

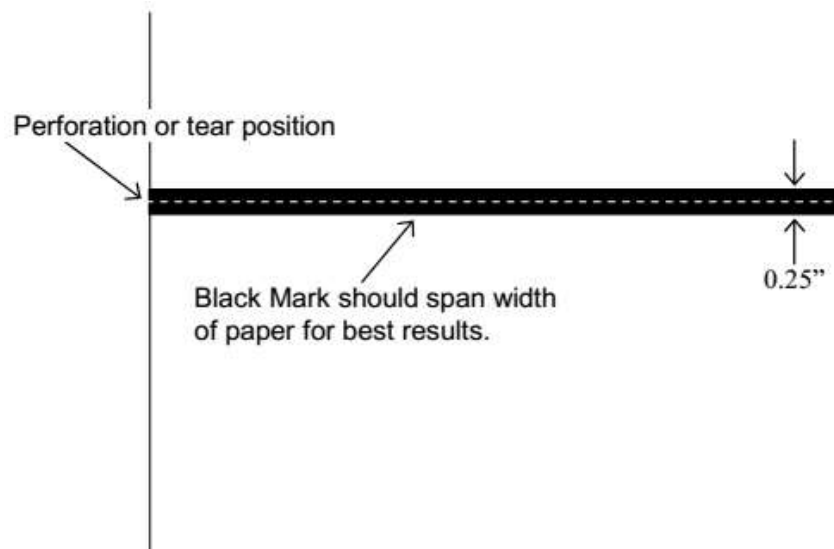

Optimum Black Mark Position

Maintenance and Troubleshooting

A. Cleaning

In normal environments, the printer should be cleaned after printing a few rolls of paper or if there are voids in the printout. For optimum performance and life, you should clean the Print Head and Platen Roller whenever you load new paper.

To clean the printer areas as described below, use a Thermal Head Cleaning Pen and MCR Cleaning Card available from Printek, or you may use cotton swabs moistened with isopropyl alcohol.

- Turn the printer off. Open the Paper Door and remove the paper.
- Using a Thermal Head Cleaning Pen, clean the white ceramic surface on the Print Head.
Caution: Do not use sharp objects to clean the print head. This may damage the printer and require service. Such damage is not covered under the warranty.
- Clean the Black Mark Sensor below the print head.
- Clean the Tear Bar.
- Clean the Platen Roller. Turn the Platen Roller with your finger to clean the entire surface.
- If a Magnetic Card Reader is installed, pass an MCR Cleaning Card through the MCR slot to clean the head.

You may also experience a buildup of paper dust in the printer. This may be removed using a can of compressed air or by vacuuming.

To clean the exterior of the printer, turn the printer off and use a soft cloth moistened with a mild detergent.

B. Troubleshooting

When encountering problems, the cause may be the printer or may sometimes be due to other problems with your system. Please review the following tables to solve common problems you may encounter with your printer. You may also visit www.printek.com for additional “FAQ’s” that may assist you.

If you are still unable to solve your problem, please contact the company from whom you purchased your printer since they are most familiar with your systems. If they are unable to help you, please contact Printek.

I. General Error Conditions

Whenever the printer detects an error condition the Alert (red) Indicator will either flash or stay on. In some cases the audible alarm will also sound. Please refer to the following table for a list of what causes these conditions and how they may be corrected.

Error Indicator	Possible Cause	Solution
Flashes	Paper Out or Paper Door not fully closed	Make sure the door is fully closed by opening the door and closing it again until the door “clicks” closed. Check the platen roller for damage.
Stays On, With Alarm	Print job too large for printer memory	Divide long documents into individual pages. Printer power must be cycled to clear error.

II. Fault Description and Resolution

Problem	Possible Cause	Solution
Printer will not turn on	AC adaptor not plugged in	Ensure plug is fully into connector.
Printer turns itself off	Electrostatic discharge	May occur in extreme low humidity conditions. Turn printer back on with power button
Poor print quality	Print head dirty	Clean print head. Refer to Maintenance section of this document.
	Poor quality or “old” paper	Verify paper from approved source. Try new roll of paper
	Obstruction in paper path or paper improperly installed	Check paper path and reinstall paper.
Paper not feeding	Poor quality paper	Verify paper from approved source
Paper does not advance to black mark reliably	Dirty Black Mark/Paper Sensor	Clean sensor
	Black mark density/contrast	Adjust Mark Sensitivity as described to Device Menu Settings
Print is compressed vertically	Poor quality paper	Verify paper from approved source
	Heavy or thick forms or specialty paper with slick finish	Lower the Max Paper Speed as described in the Device Config Menu.

C. Obtaining Service

If service is required for your printer, please contact the company where you purchased your printer.

If they are unable to assist you, contact Printek retailer to obtain a Return Authorization Number. Printers without Return Authorization will not be accepted.

APPENDIX

A. Appendix A – I80 Printer Specifications

Printing Specifications

Printing Method: Direct thermal.
Printing Resolution: 203 dpi (8 dots per mm).
Printing Speed: Up to 2 ips (11 pages per minute).
Printing Width: Up to 8.27" (210mm), or A4 width.

Fonts/Characters/Bar Codes

Fonts: Virtually all TrueType fonts, from 6 cpi to 22 cpi depending on emulation chosen, plus scaling.
International Characters: All common sets available via UTF-8 encoding.
Bar Codes: Support common 1D and 2D codes, depending on emulation chosen.
Downloadable firmware, fonts, graphics, and logos.

Connectivity

Standard (All Units): USB 2.0 PNP.
USB-B mini connector.

Wireless Options:

- Bluetooth®
 - Complete Bluetooth® 4.0
 - Dual mode with EDR
 - Wi-Fi 802.11b/g/n compatible

Software

Drivers and Utilities: Drivers for WIN 7, WIN 8, WIN 10. Compatible with Windows Mobile and Android. Print utilities and SDK's for all platforms.
Native App and Web printing.
Printer Setup via internal web page, access with browser from any host (tablets and smartphones included).
Emulations: Emulates many popular printer brands and languages including Zebra CPCL and ZPL and ESC POS.
Firmware can be upgraded as new emulations become available.
Supports direct printing of Postscript, PDF, PBM, JPG, PNG, BMP, SVG and TIFF files.

Print Media

Paper Type: Direct Thermal Roll, Fanfold and Cut sheet.

Power Management

Power Option: 100-240 VAC wall adapter. or 12 VDC in-vehicle adapter

Physical Specifications

D x W x H: 2.16" x 10.04" x 1.18" (55 x 255 x 30 mm)

Environmental Specifications

Operating Temp: -10° to 45°C Storage Temp: -20° to 60°C
Humidity: 10% to 90% RH (non-condensing).

Operator Controls and Indicators

3 LED indicators for general fault, power and update status indication.
Buttons for power and paper feed.
Sensors for paper out, black mark detection, and door open.

Memory Capacity

256 MB Flash, 512 MB DDR2.
Standard memory supports large and graphic intensive print jobs.

Durability and Reliability

Durable PC-ABS case.
Print head life: min 50km @ 12.5% coverage
MTBF: 20,000 hours in normal use.

Regulatory Approvals

FCC Class B, CE mark, RoHS, UL listed AC adapters.

Warranty

2-year printer warranty on the entire printer – case, print head, included.

Accessories & Options

- Direct thermal roll, approx. 3m/roll (if shipped with printer)
- AC Wall Adapter, 100 to 240 VAC (with power cord) (model GST60A12-P1JR or GST60A12-P1J)
- In-vehicle Power Adapter, 12-24 VDC
- Data cable: USB (USB-A to USB-B mini)
- Fanfold tray
- Media in Case Quantities
- Popular Mounting Systems
 - In-Vehicle Systems
 - Cart Mounting Systems
 - Fixed Mounting Systems

Glossary of Terms

802.11	Wireless networking communication standards created by IEEE.
Ad-Hoc	A Wi-Fi network consisting of only stations (no access point). Same as Peer-to-Peer.
authentication	The process a Wi-Fi station uses to identify itself to another station.
Bluetooth	A definition for short range radio frequency communications.
client	Any node on a network that requests services from another node (server).
character pitch	The horizontal spacing of characters. Measured in cpi.
cpi	Characters per inch.
default	Value or configuration assumed when the printer is powered on or reset.
DHCP	Dynamic Host Configuration Protocol. A method used to centrally control the assignment of IP addresses on a network.
dpi	Dots per inch. Generally used to refer to graphics density or resolution.
font	A group of characters of a given shape or style.
infrastructure	A Wi-Fi network consisting of stations connecting to a wired network or other stations via an access point.
interface	The connection between the printer and the host computer.
IP	Internet Protocol. A specification for packets, or datagrams, of data and an addressing method to allow the exchange of data with another system. Must be combined with another protocol such as TCP to create a complete connection with the other system.
LAN	Local Area Network.
LED	Light emitting diode.
lpi	Lines per inch.
margin	An area along any edge of a form where data may not be printed.
Peer-to-Peer	A network consisting of only stations (no access point or central server). Same as Ad-Hoc.
reset	Initialization of various operating features of the printer to the value or state assumed when the printer is powered on.
server	Any node on a network that provides services to another node (client).
SSID	Service Set Identifier. An identifier attached to packets on a Wi-Fi network that identify the particular network the packets are intended for.
TCP	Transmission Control Protocol. A specification that controls the connection between systems on a network.
top of form	The vertical position where the first line is printed on the paper. Also the position the paper is advanced to when a form feed (FF) character is received from the host or the Form Feed button is pressed on the printer's control panel.
USB	Universal Serial Bus.
WAN	Wide Area Network. Refers to connections that allow one LAN to communicate with another LAN(s).
WEP	Wired Equivalent Privacy. A security protocol for wireless LANs designed to provide data security similar to a wired LAN.
Wi-Fi	Refers to any of the IEEE 802.11 standards.
WLAN	Wireless Local Area Network. A LAN made up of wireless nodes.

Index

- 802.11, 30
- Add Enterprise Network, 11
- Add Personal Network, 11
- Address Method, 10
- Ad-Hoc, 30
- Alert, 6
- Android, 3, 20
- Android Tablets & Smart phones, 20
- Apple, 3, 21
- authentication, 30
- Auto Off Timer, 15
- AUTOIMAGE, 12
- Available Networks, 11
- Backup Distance Before Printing, 14
- Bluetooth, ii, 2, 8, 9, 19, 20, 21, 30
- Canadian Department of Communications Radio Interference Statement, i
- character pitch, 30
- Cleaning, 23, 29
- client, 30
- Com Port, 19
- Configuration, 7, 22, 30
- Connectivity Parameters, 8
- Contrast, 14
- Control Panel, 6
- CPCL, ii, 12
- cpi, 30
- Current Emulation, 12
- Current Logo Mapping, 16
- Current Printer Config, 10
- default, 30
- Default Font, 12
- Default Text Line Spacing, 13
- Device Config, 13
- DHCP, 30
- discover name, 19, 21
- Discoverability, 9
- dpi, 30
- driver, 19
- Drivers, 19
- ESCPOS, 12
- Fault Description and Resolution, 25
- FCC Part 15 Class B, i
- features, 31
- Font Aliases, 15
- Fonts, 15
- form, 31
- Front Paper Sensor Threshold, 14
- Gap Paper Sensor Threshold, 14
- GateWay, 10
- General Error Conditions, 25
- Graphics, 16
- IMAGE, 12
- Image Parameters, 12
- infrastructure, 30
- interface, 30
- IP Address, 10
- IP54, 3
- LAN, 30
- LED, 30
- Left Margin, 14
- lpi, 30
- Maintenance, 2, 23, 26
- margin, 30
- Mark Seeking, 14
- Max Mark Search Distance, 14
- Max Paper Speed, 13, 26
- Media, 2, 22, 27, 28, 29
- Mounting Options, 29
- Obtaining Service, 26
- Paired Mode, 8
- pairing code, 19
- Paper Energy Values, 14
- Paper Feed Button, 6
- Paper Load, 4
- passkey, 19, 21
- PDF, 12
- Peer-to-Peer, 30
- PIN, 8, 9
- POSTSCRIPT, 12
- power, i, ii
- Power Button, 6
- Power On, 5
- Quick Start Instructions, 4
- Rear Paper Sensor Threshold, 14
- Reset, 31
- Role Policy, 9
- Safety Information, 24
- Self-Test, 6, 24
- server, 31
- Set Date, 11
- Set index, 16
- Set Width, 16
- Specifications, 2, 3, 27, 28
- SSID, 31
- Stop Distance after Mark, 14
- SubNetMask, 10
- Supplies and Accessories, 2, 29
- TCP, 31
- Troubleshooting, 2, 23, 24, 25
- Units, 13
- Upload Digital Certificate, 12
- Upload File, 16
- Upload Font File, 15
- USB, 19, 31
- USB port, 2, 19
- WAN, 31
- web page, 7
- WEP, 31
- Wi-Fi, ii, 2, 20, 30, 31
- WI-FI Config, 8, 9
- Wifi Port, 10
- Windows, ii, 3, 18, 19, 20
- WLAN, 31
- ZPL, 12

